

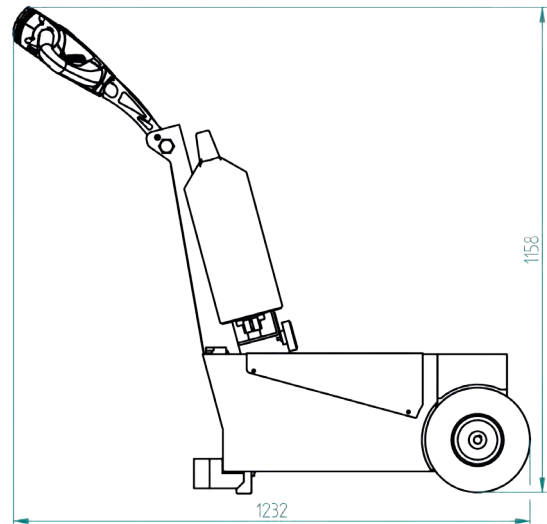

Specifications T1500-D

| | |
|------------------|-------------------------|
| Frame | Steel, powder coated |
| Drive | 24V DC, 600W, 100 rpm |
| Weight | 180 kg |
| Weight trailer | 1500 kg |
| Battery | Exchangable batterypack |
| Speed | Max. 4,7 km/h |
| Drive wheels | Full rubber ø250x80 mm |
| Width | 486mm |
| Length | 1232mm |
| Adze height | 750-1158mm |
| Folded | 770mm |
| Noise level | 68,5 dB |
| To use from | -40 °C / 70 °C |
| Protection class | Machine IP44 |

Dimensions T1500-D

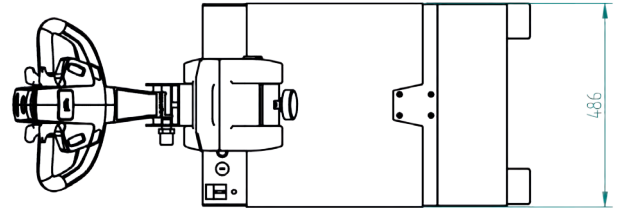

Pulling power T1500-D (in kg)

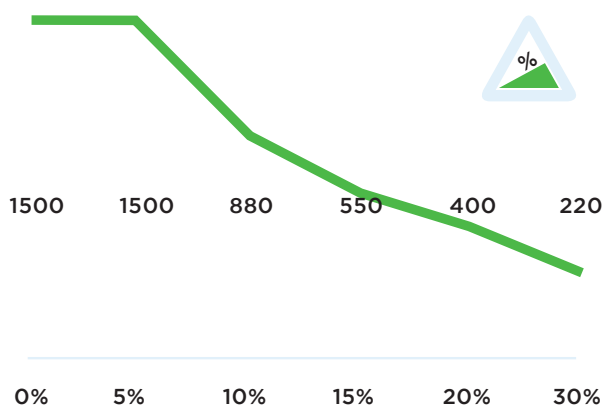

*Measured with a trolley with 2 swivelwheels and 2 fixed castors. Wheel diameter: 160mm

Standard T1500-D



Standard parts T1500-D

Charger 24V 5A incl. charging cable



Item number:
OPT0009

Batterie AGM 22Ah



Item number:
OPT110

Full-rubber drive wheel, black Ø250mm



Dimensions Ø250 x 80 mm

Item number:
M0248

Adjustable tillerhead



Item number:
Standardpart 1

Safety switch



Item number:
Standardpart 2

2 programmable speeds



Item number:
Standardpart 3

Standard parts T1500-D

Engine 600W 100RPM
BRAKE 6911413X



Item number:
M2098

LED battery indicator
LBF318-24V



Item number:
M0123

Options T1500-D



Extra plug to recharge the battery

for on-machine batterie charging

Article number:
OPT0001



Battery Lithium-LiFePO4,
36Ah GREEN

Article number:
OPT0106



Battery upgrade to Lithium-LiFePO4, 36Ah

iso AGM Battery (!) Including upgrade to lithium charger 10A

Article number:
OPT0107



Batterie AGM 22Ah

Article number:
OPT0110



Upgrade Nonmarking
tires (2) yellow CR

Article number:
OPT0357



Upgrade Nonmarking
tires (2) grey

Article number:
OPT0359



Horn 90dB

Article number:
OPT0045



Emergency stop complete

Article number:
OPT0063



Strobelight cast iron tiller head

Article number:
OPT0076



Drive wheels safety fender
T1500-D

Article number:
OPT0094



Strobelight on pole
T1000-D/T1500-D

Article number:
OPT0124

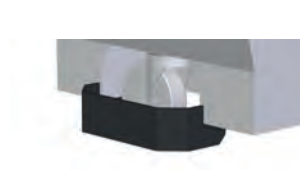

Cover for caster T1500-D

Article number:
OPT0130

Options T1500-D

Safety Fender for T1500-D



Article number:
OPT0167

Acoustic signal driving backwards



Article number:
OPT0254

Radio remote



6-channel

Article number:
OPT0026-5

Push Bar



Article number:
OPT0048

hour counter complete



Article number:
OPT0056

Antistatic strip



Article number:
OPT0058

Code lock



Article number:
OPT0068

Document holder



Article number:
OPT0127

Preparation electric hook



Article number:
OPT0143

Ignition key unequal key



Article number:
OPT0145

Ignition key equal key 701



Article number:
OPT0146

Customized programming



please indicate specific settings

Article number:
OPT0170

Options T1500-D



Maximum weight

Article number:
OPT0172



Programmer for Italsea

Article number:
D0003



Wall mounted Charger, for
AGM battery

*Complete charger-unit Includ-
ing AGM battery charger (5
Ah)*

Article number:
OPT0015



Charging Station for 1
Lithium battery

*Wallmounting chargerstation
with lithium battery charger
29,2 V, 10 A*

Article number:
OPT0023



Charging station for 5
Lithium batteries

Article number:
OPT0029



Charging station for 5
batteries

*Upright standing charging
station with five separate AGM
battery chargers 24 V, 5 A*

Article number:
OPT0039



U-Frame for waste contain-
er 1000/1100L

Article number:
OPT0088



Adaptor fo 2 wheel bins

Article number:
OPT0151



Upgrade to charging
station

Article number:
OPT0261



Adaptor for shopping
trollies (90°)

adjustable in width

Article number:
OPT0324

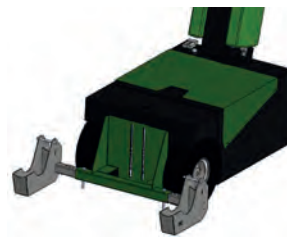

Adaptor for loggagetrol-
lies (90°)

adjustable in width

Article number:
OPT0327



Base part hook 15° double
spring

Article number:
H7020

Options T1500-D



Base part hook 90° double spring

Article number:
H7040

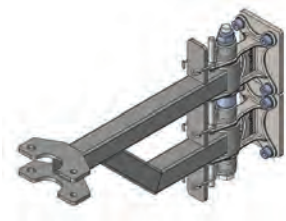

Base part heavy hook 90° lowered

Article number:
H7070

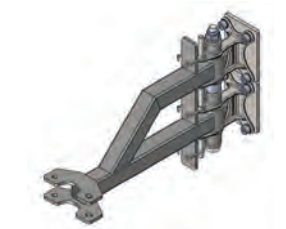

Base part heavy hook 90° raised

Article number:
H7080

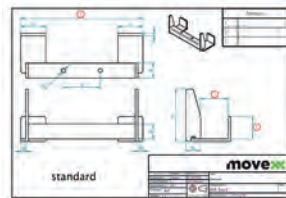

Customized Hook

Please complete corresponding sheet (!)

Article number:
HA5000

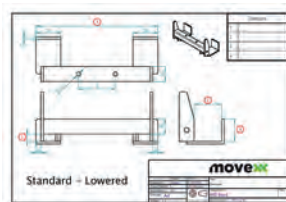

Customized Hook (LOWE-RED)

Please complete corresponding sheet (!)

Article number:
HB5000

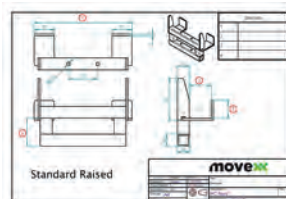

Customized Hook (RAI-SED)

Please complete corresponding sheet (!)

Article number:
HC5000

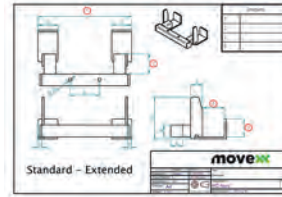

Customized Hook (EX-TENDED)

Please complete corresponding sheet

Article number:
HD5000

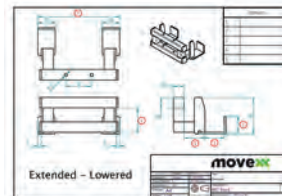

Customized Hook (EX-TENDED / LOWERED)

Please complete corresponding sheet

Article number:
HE5000

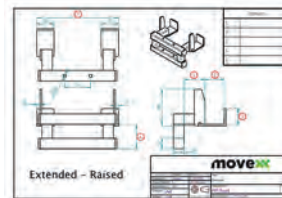

Customized Hook (EX-TENDED / RAISED)

Please complete corresponding sheet

Article number:
HF5000

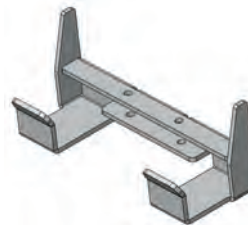

HA245.55.45.15.0

Fronthook for 50mm. Profile, Heavy Duty Hook

Article number:
H0004



Pen for Drawbar Ø16 incl. Backplate

Article number:
H0064



hitch ball coupling Ø 50mm incl. adapter

Article number:
H0068

Options T1500-D



Towbar for Movexx E-Frame

Suitable for OPT0067

Article number:
H0070



Towbar + pin Ø15mm incl. Back plate

Article number:
H0071



Pen for Drawbar Ø10 incl. Backplate

Article number:
H0072



Hook for LKE Platformwagon Type X

Article number:
H0076



Hook K-Hartwall dolly DOS1617/1636 90°

Article number:
H0083

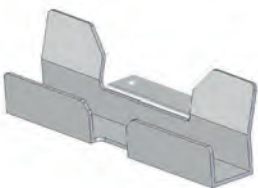

HA250.35.30.0.0

Hook for 30 mm. Profile For furniture trolley

Article number:
H0097



Folding Hook, diameter 16

Article number:
H0128-D16



Folding Hook, diameter 20

Article number:
H0128-D20



Folding Hook, diameter 25

Article number:
H0128-D25



Folding Hook, diameter 27

Article number:
H0128-D27



Folding Hook, diameter 32

Article number:
H0128-D32



Folding Hook, diameter 35

Article number:
H0128-D35

Options T1500-D

Hook locking system



Article number:
OPT0012

Electric lifting module for
Hooks



Article number:
OPT0050

Folding hook for flower
trolleys



Article number:
OPT0099

Electrical locking module
for hook



Article number:
OPT0129

Movexx Parking label



Article number:
OPT0245

HA270.43.40.0.0

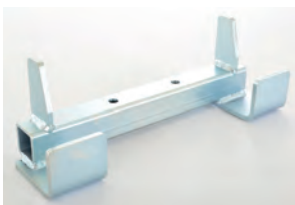

*Fronthook for 40mm. pro-
file. Hartwall Pallet-Trolley
(DOS1870)*

Article number:
H0003

HA250.43.35.0.0



Front hook 40mm. profile

Article number:
H0051

HD370.73.35.0.40



*Fronthook for 70mm. profile
(Flower container)*

Article number:
H0055

HA245.142.35.0.0



*Fronthook for 140mm. profile
(wooden trolley)*

Article number:
H0057

Trailer coupling with
frame pen Ø25mm



Article number:
H0062

HA250.23.27.0.0



Fronthook for 20mm. profile

Article number:
H0067

HB245.60.45.30.0



*Fronthook for FEIL plastic floor
trolley*

Article number:
H0092

Options T1500-D



HA250.28.30.0.0

Fronthook for 25mm. profile

Article number:
H0094

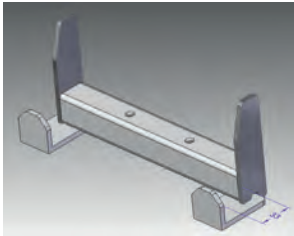

HA250.33.30.0.0

Fronthook for 30mm. profile

Article number:
H0095



HF242.23.30.15.20

*Fronthook for 20 mm. profile
(Hospital Logistics)*

Article number:
H0116



Spring hitch 16 mm

Pin 16 mm.

Article number:
H0120

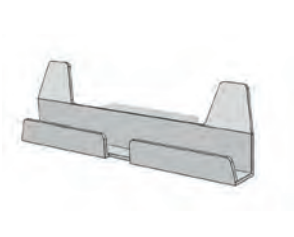

HA250.23.20.0.0

Hook for 20 mm. profile

Article number:
H0123



Coupling nettingscontainer,

Nettings 6mm

Article number:
K0007



Coupling rollcontainer

Nettings 10mm.

Article number:
K0008



Coupling Rollcontainer

Width 42 mm.

Article number:
K0010



Coupling with carabiners

Article number:
K0026

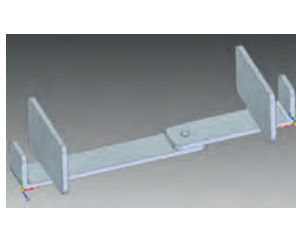

Coupling jaw 20mm

Article number:
K0027



Coupling trolleys side R28

Article number:
K0028



Coupling Open Front-Closed Backside

Article number:
K0030

Options T1500-D

Welding part for trolley's

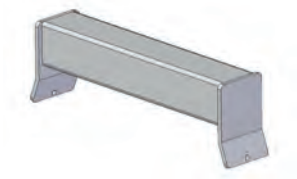

Profile 50x50mm.

Article number:
OPT0032

Bolt-on part for Trolley's



Profile 50x50mm.

Article number:
OPT0033

Angle limitation



Stainless steel

Article number:
OPT0244

Diagnostic connector

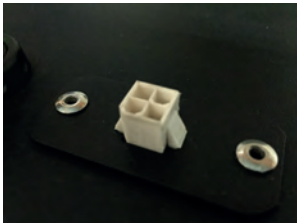

Article number:
OPT0270



Movexx International B.V.

Generatorstraat 17

3903 LH Veenendaal

Tel +31 (0)318 51.99.00

Fax +31 (0)318 50.80.20

E-mail info@movexx.nl